

**DO YOU WANT TO AIM EVEN HIGHER?
FOR THIS, THERE IS DIGIMAR.**

Mahr offers you a complete range of products in order for you to obtain the most reliable solution for all your measuring tasks. Whether it's simply scribing a work piece or completing complex measurements in two dimensions – Digimar Height Measuring Instruments guarantee a maximum of both flexibility and quality. Our motorized Height Measuring Instruments Digimar 817 CLM and 816 CL exceed all customer requirements: they are simple to operate, all the basic functions can be executed with a single key and they offer maximum ease and accuracy.

Digimar. Height Measuring Instruments

Overview

Digimar Height Measuring Instruments 76

Motorized Height Measuring Instruments

Digimar 817 CLM 78
Height Measuring Instrument

Digimar 816 CL 79
Height Measuring Instrument

Accessories for 817 CLM and 816 CL 80

Manual Height Measuring Instruments

Digimar 814 N 87
Height Measuring and Scribing Instrument

Digimar 814 G 89

Height Measuring and Scribing Instrument

Digimar 814 SR 91
Height Measuring and Scribing Instrument

Mahr

Digimar 817 CLM Quick Height

The new Height Measuring Instrument **Digimar** 817 CLM with the innovative Quick Mode. Highly accurate rapid measurements, a wide range of measuring and evaluation options and excellent operator comfort.

The best solution for all measuring tasks



Fast measurement per hand
Easy to operate due to the "Quick Mode"; an innovative solution from Mahr (patented).



Ill. 1. Move the measuring carriage by hand in the direction of the object to be measured.



Ill. 2. The motor starts, the measurement procedure will automatically be performed.

Measurement using the keypad (speed keys) on the base



Ideal in conjunction with the air bearings for large work pieces.

By using the keys that are integrated into the base, the operator can comfortably move the measuring carriage into the desired position and start a measurement. This eases measurement, particularly when measuring large workpieces as these do not have to be moved into position. The operator can keep both hands on the measuring instrument (one hand on the key for the air bearing and other on the high-speed keys) and measure the workpiece in one run.



Highest accuracy and reliability

- Extremely accurate incremental measuring system with double reader head system, insensitive to the contamination of dirt
- Robust guide column, made from stainless steel
- Measuring head in precision ball bearings guide
- Temperature compensation with an integrated temperature sensor



Ergonomic operating and display unit



- The display unit can be positioned freely with the swivel arm

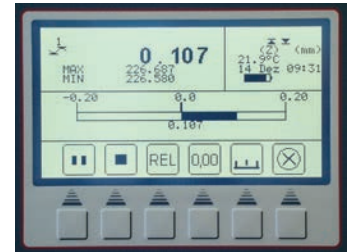

- Large, back-lit display
- Self-explanatory guided operation with icons



Easy to operate all measurement functions with the function keys due to the clearly defined symbols.

Universal measurement possibilities

- Wide range of measurement functions in 1D or 2D
- Dynamic measurement functions with the analog display
- Automatic perpendicularity and straightness measurements (in conjunction with accessories)
- Automated measuring procedures (measurement programs)
- Auto function for chain measurements and distance measurements

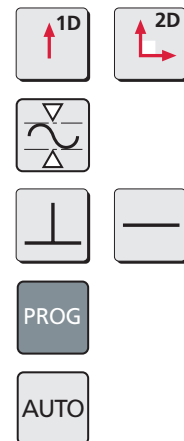

Extensive evaluation possibilities

- Transmit data to a PC via RS232 or USB (with an adapter) for example, into MS Excel via the MarCom Software
- Print measured values, statistics, etc. via a USB printer
- Save measured values in the integrated USB memory (will be recognized by a PC as an interchangeable disc drive) or on a USB dangle
- Broad range of statistical evaluations are available

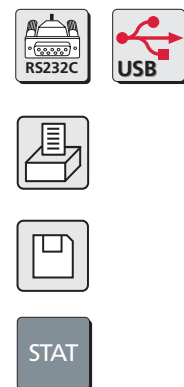

Height Measuring Instrument Digimar 817 CLM



- Top or bottom contacting
- Web width or distances between grooves, including center of web or groove
- Bore or shaft diameter, including center of bore or shaft
- Bore reversing point (up or down)
- Shaft reversing point (up or down)
- Calculating distances or symmetry
- Dynamic measuring functions
- Perpendicularity measurement
- Straightness measurement
- Measurement in 2D mode
- Measuring programs
- Statistical evaluation
- Measuring data processing
- Large and clearly defined function keys
- Easy to read background lit graphic LCD-Display
- Operator guidance with self-explanatory icons / pictograms
- Operator prompts and menus are available in several languages
- Possible to set additional zero points on a work piece
- Additional measurement instruments with Opto RS232-interface can be connected
- Secure the future due to software update potential
- Automatic Stand-by switch mode
- Selectable Auto-off function, without loss of measured values
- Excellent accuracy and reliability due to the optical incremental measurement system with the double reader head
- Dynamic probing system enabling high repeatability
- Air bearings system for light and smooth movement
- Precise measuring head on stainless steel guideways
- Motorized measuring carriage simplifies measurement runs
- Probe constant remains after the instrument is switched off
- Integrated rechargeable battery with a long operating time span for power source independent measurement
- Temperature compensation with an integrated temperature sensor
- **Software:** MarCom Professional free download: www.mahr.com/marcom (only for Mahr data cables and wireless systems with USB and RS232 interface)
- **Scope of delivery:** Height Measuring Instrument incl. Operating and display unit, Carrier 817h1, Probe K6/51, Setting block 817 eb, Instruction manual, Power source, USB cable, Protection cover, Calibration certificate

Technical Data

Order no.		4429010	4429011	4429012
Product type			817 CLM	
Measuring range	mm	0 – 350	0 – 600	0 – 1000
Measuring range	inch	0 – 14"	0 – 24"	0 – 40"
Application range from	mm		170	
Application range to	mm	520	770	1170
Resolution	mm	0,01, 0,005, 0,001, 0,0005, 0,0001		
Resolution	inch	.001", .0005", .0001", .00005", .00001"		
Error limit	µm	(1.8+L/600) L in mm		
Repeatability bores	µm	1		
Repeatability plane	µm	0,5		
Perpendicularity error	µm	5	6	10
Operation time max.	h	10		
Measuring force	N	1.0 +/-0.2 N		
Relative humidity non-condensing	%	65		
Working temperature	°C / °F	20 / 68		
Operating temperature	°C / °F	10 –40 / 50–104		
Product weight	kg / lbs	25,00 / 55.15	30,00 / 66.14	35,00 / 77.16
Data interface		USB, RS232C, Wireless		
Standard		Factory standard		

Accessories

Order no.	Product description	Product type
7024634	Data Connection Cable RS232C (3 m)	
4102333	Adapter Cable RS232-USB (1 m)	817 usb
4102233	Transmitter for e-Stick	RS232 e
4102230	Receiver	e-Stick
4221525	Surface Plate made from granite, 1000 x 630 mm	107 G
4221573	Stand, 1000 x 630 mm	107 Ug
4221526	Surface Plate made from granite, 1200 x 800 mm	107 G
4221574	Stand, 1200 x 800 mm	107 Ug



e-Stick



107 Ug

Height Measuring Instrument Digimar 816 CL



Basic measuring functions

- Top or bottom contacting
- Web width or distances between grooves, including center of web or groove
- Bore or shaft diameter, including center of bore or shaft
- Bore reversing point (up or down)
- Shaft reversing point (up or down)
- Calculating distances or symmetry
- Dynamic measuring functions
- Measuring program
- Measuring data processing
- Easy to read background lit graphic LCD-Display
- Large and clearly defined function keys
- Operator guidance with self-explanatory icons / pictograms
- Possible to set additional zero points on a work piece
- Memory can store up to 99 measured values
- MarConnect Data output, select either:
 - USB
 - OPTO RS232C
- Excellent accuracy and reliability due to the optical incremental measurement system with the double reader head
- Dynamic probing system enabling high repeatability
- Air bearings system for light and smooth movement
- Precise measuring head on stainless steel guideways
- Motorised measuring carriage simplifies measurement runs
- Temperature compensation with an integrated temperature sensor
- Probe constant remains after the instrument is switched off
- Integrated rechargeable battery with a long operating time span for mains independent measurement
- **Software:** MarCom Professional free download:
www.mahr.com/marcom (only for Mahr data cables and wireless systems with USB and RS232 interface)
- **Scope of delivery:** Height Measuring Instrument incl. Operating and display unit, Carrier 817h1, Probe K6/51, Setting block 817 eb, Instruction manual, Power source, Protection cover, Calibration certificate



Technical Data

Order no.		4429030	4429031
Product type		816 CL	
Measuring range	mm	0 - 350	0 - 600
Measuring range	inch	0 - 14"	0 - 24"
Application range from	mm	170	
Application range to	mm	520	770
Resolution	mm	0,01, 0,001	
Resolution	inch	.00005", .0001"	
Error limit	µm	(2.8+L/300) L in mm	
Repeatability bores	µm	3	
Repeatability plane	µm	2	
Perpendicularity error	µm	15	20
Operation time max.	h	10	
Measuring force	N	1.0 +/- 0.2 N	
Relative humidity non-condensing	%	65	
Working temperature	°C / °F	20 / 68	
Operating temperature	°C / °F	10 - 40 / 50 - 104	
Product weight	kg / lbs	25.00 / 55.15	30.00 / 66.14
Data interface		Opto RS232C, USB, Wireless	
Standard		Factory standard	

Accessories

Order no.	Product description	Product type
4346023	Data connection cable USB (2 m)	2000 usb
4346020	Data Connection Cable RS232C (2 m)	2000 r
4102232	Transmitter for e-Stick	2000 e
4102230	Receiver	e-Stick
4221526	Surface Plate made from granite, 1200 x 800 mm	107 G
4221574	Stand, 1200 x 800 mm	107 Ug
4221525	Surface Plate made from granite, 1000 x 630 mm	107 G
4221573	Stand, 1000 x 630 mm	107 Ug



e-Stick



107 Ug

Probe set Digimar 817 ts 1

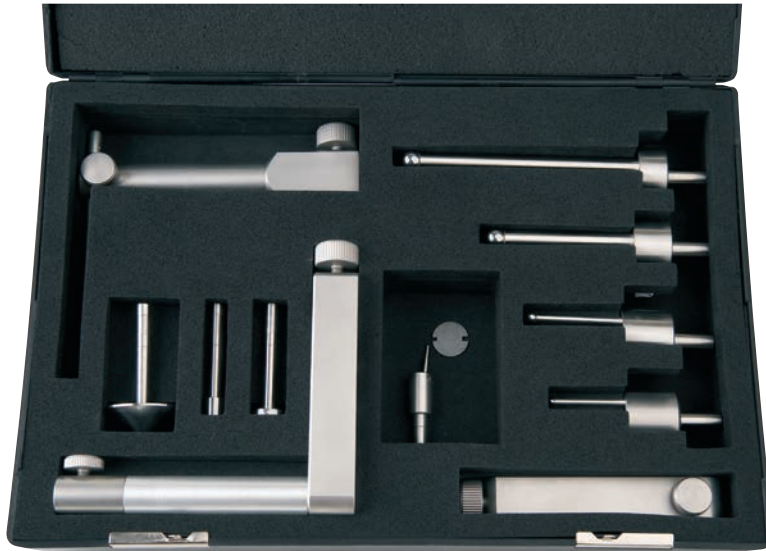

- Large accessory kit
- Packaged in a practical plastic case
- Consisting of:
 - Depth probe
 - Carrier with extended holder
 - Disc measuring probe for grooves, etc.
 - Conical measuring probe
 - Cylindrical measuring probe
 - Holder for test indicator styli with M2 thread
 - Carrier including 4 spherical probes with shaft diameter 8 mm
- **Scope of delivery:** Case

Technical Data

Order no.	Product type
4429019	817 ts 1

Components included in set

Order no.	Product description	Product type
4429219	Carrier for a probe, Mounting hole 6 mm, a = 100,5 mm, b = 119,5 mm, c = 84 mm	817 h2
4429226	Disc probe \varnothing 15 mm	S15/31,2
4429227	Cylindrical probe \varnothing 10 mm	Z10/31,2
4429228	Taper probe	MKe 30
4429221	Depth probe incl. carrier	TMT 120
4429256	Probe M2 incl. styli 800 ts \varnothing 2,0 mm	KM 2
4429220	Carrier for probes 817 CLM, Mounting hole 8 mm	817 h4
7023813	Probe with mount, \varnothing 4,0 mm	K 4/30
7023816	Probes with mount, \varnothing 6 mm	K 6/40
7023810	Probes with mount, \varnothing 10,0 mm	K 10/60
7023615	Probes with mount, \varnothing 10,0 mm	K 10/100

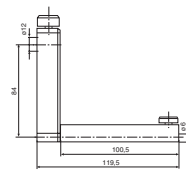

817 h2

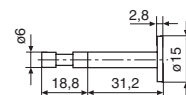

S15/31,2

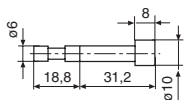

Z10/31,2

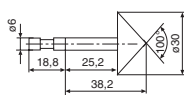

MKe 30

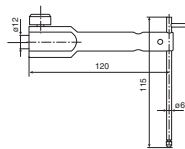

TMT 120

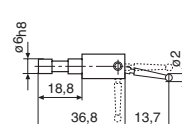

KM 2

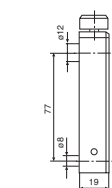

817 h4

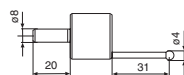

K 4/30

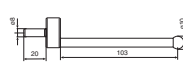

K 10/100



K 6/40

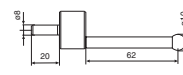

K 10/60

Probe set Digimar 817 ts2

- Small accessory kit
- Packaged in a practical plastic case
- Consisting of:
 - Depth probe
 - Carrier with extended holder
 - Disc measuring probe for grooves, etc.
 - Conical measuring probe
 - Cylindrical measuring probe
 - Holder for test indicator styli with M2 thread
- **Scope of delivery:** Case

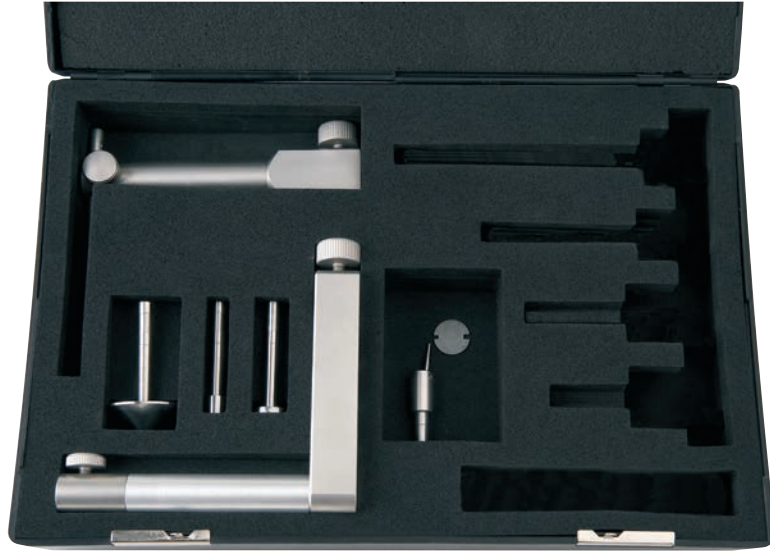

Technical Data

Order no.	Product type
4429018	817 ts2

Components included in set

Order no.	Product description	Product type
4429219	Carrier for a probe, Mounting hole 6 mm, a = 100,5 mm, b = 119,5 mm, c = 84 mm	817 h2
4429226	Disc probe \varnothing 15 mm	S15/31,2
4429227	Cylindrical probe \varnothing 10 mm	Z10/31,2
4429228	Taper probe	MKe 30
4429221	Depth probe incl. carrier	TMT 120
4429256	Probe M2 incl. styli 800 ts \varnothing 2,0 mm	KM 2

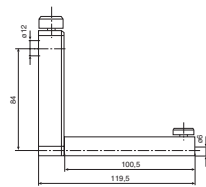

817 h2

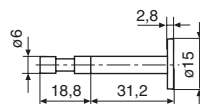

S15/31,2

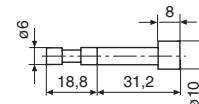

Z10/31,2

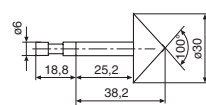

MKe 30

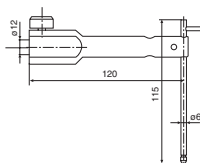

TMT 120

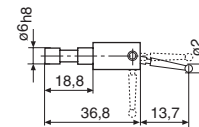

KM 2

Universal probe set Digimar 817 ts3



Accessory kit for small parts and delicate grooves, recesses and bores

- Packaged in a practical wooden case
- Suitable for 817 h4 carriers with 8 mm mounting bore (4429220)
- Consisting of:
 - Base with 8 mm holding shaft
 - Depth probe
 - Probe shoe for grooves and recesses
 - Spherical measuring probe
 - Conical measuring probe
 - Extension
 - Adapter for M2.5 measuring anvils
- **Scope of delivery:** Case

Technical Data

Order no.	Product type
7034000	817 ts3

Components included in set

Order no.	Product name	Product type
3015917	Probe carrier	Gk/8
3015918	Measuring crook, $d = 0,5 \text{ mm}$, $l = 78 \text{ mm}$	TS 0,5/78
3015919	Probe pin/tip, $d = 1,2 \text{ mm}$, $l = 75 \text{ mm}$, $l_s = 15,5 \text{ mm}$	T 1,2/75
3015920	Taper probe	MKe 8
3022000	Spherical probe, $d_k = 3,0 \text{ mm}$, $l = 24 \text{ mm}$	K3/24
3022001	Spherical probe, $d_k = 2,0 \text{ mm}$, $l = 24 \text{ mm}$	K2/24
3022002	Spherical probe, $d_k = 1,0 \text{ mm}$, $l = 24 \text{ mm}$	K1/24
3015888	Extension M3 - M2,5, $d = 4 \text{ mm}$, $l = 20 \text{ mm}$	V/M2,5
3015921	Extension M3 - M3, $d = 4 \text{ mm}$, $l = 20 \text{ mm}$	V/M3

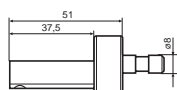

Gk/8

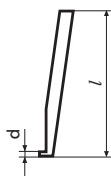

TS 0,5/78

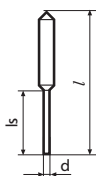

T 1,2/75

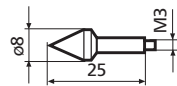

MKe 8

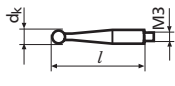

K3/24

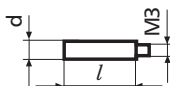

V/M2,5; V/M3

Carrier for a probe Digimar 817 h1 / 817 h2 / 817 h5

- Carrier for probes with 6 mm holding shaft
- Used for measurements at increased measuring depth (817 h2)
- Pivoting (817 h5) e.g. for aligning a cylindrical measuring probe



Technical Data

Order no.	Product type
4429154	817 h1
4429219	817 h2
4429454	817 h5

Order no.	a	b	c	Mounting hole
	mm	mm	mm	
4429154	27,5	46,5	84	6 mm
4429219	100,5	119,5	84	6 mm
4429454	35	54	86	6 mm

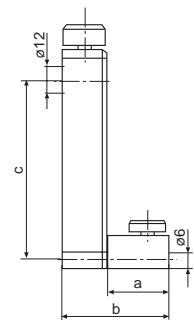

Accessories

Order no.	Product description	Product type
4301865	Mounting shaft \varnothing 6 mm	800 a6
4429158	Spherical probe, \varnothing 5,0 mm	K5/51
4429226	Disc probe \varnothing 15 mm	S15/31,2
4429227	Cylindrical probe \varnothing 10 mm	Z10/31,2
4429228	Taper probe	MKe 30
4429254	Spherical probe for 817 CLM, \varnothing 6 mm	K6/51
4429256	Probe M2 incl. styli 800 ts \varnothing 2,0 mm	KM 2

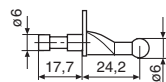

K6/51

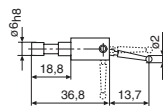

KM 2

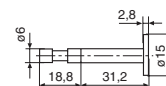

S15/31,2

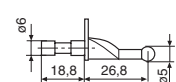

K5/51

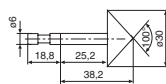

MKe 30

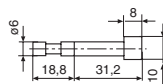

Z10/31,2

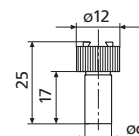

800 a

Carrier for probes 817 CLM Digimar 817 h4



- Carrier for measuring anvils with 8 mm holding shaft and weighing 102 g
- Suitable for the CXt2 universal measuring probe set
- Compatible with Digimar CX1 and CX2 probes weighing 102 g

Technical Data

Order no.	Product type
4429220	817 h4

Order no.	Mounting hole
4429220	8 mm

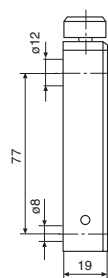

Accessories

Order no.	Product description	Product type
3015888	Extension M3 - M2,5, d = 4 mm, l = 20 mm	V/M2,5
3015917	Probe carrier	CXt2
3015918	Measuring crook, d = 0,5 mm, l = 78 mm	CXt2
3015919	Probe pin/tip, d = 1,2 mm, l = 75 mm, ls = 15,5 mm	CXt2
3015920	Taper probe	CXt2
3015921	Extension M3 - M3, d = 4 mm, l = 20 mm	CXt2
3022000	Spherical probe, d _k = 3,0 mm, l = 24 mm	CXt2
3022001	Spherical probe, d _k = 2,0 mm, l = 24 mm	CXt2
3022002	Spherical probe, d _k = 1,0 mm, l = 24 mm	CXt2
7023615	Probes with mount, ø 10,0 mm	K 10/100
7023810	Probes with mount, ø 10,0 mm	K 10/60
7023813	Probe with mount, ø 4,0 mm	K 4/30
7023816	Probes with mount, ø 6 mm	K 6/40

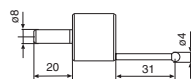

K 4/30



K 6/40

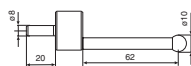

K 10/60

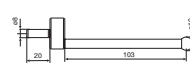

K 10/100

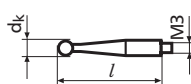

K1-3/24

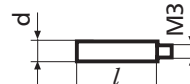

V/M2,5;V/M3

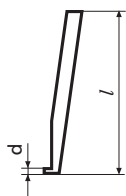

TS 0,5/78

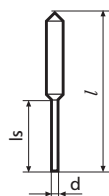

T 1,2/75

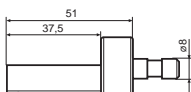

Gk/8

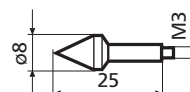

MKe 8

Depth probe incl. carrier Digimar TMT 120 / TMT 120 S

- Depth probe and carrier for measurements in vertical bores and recesses
- Interchangeable depth probe
- M2 and M2.5 connecting threads for measuring anvils
- M2.5 spherical contact point 901 H
- pivoting (TMT 120 S only)
- Second depth probe with probe shoe for groove measurement (TMT 120 S only)
- M2 stylus 800 ts with 2 mm ball (TMT 120 S only)

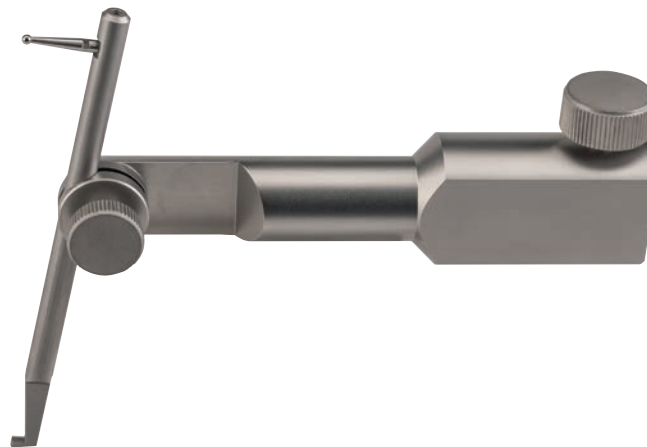

Technical Data

Order no.	Product type
4429221	TMT 120
4429421	TMT 120 S

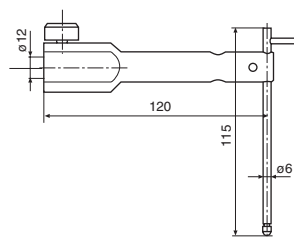

TMT 120

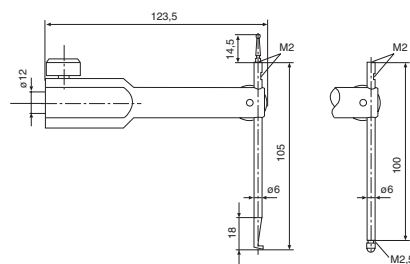

TMT 120 S

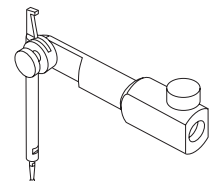

Accessories

Order no.	Product description	Product type
4305870	Stylus ϕ 1,0 mm, Carbide, $l = 14,5$ mm	800 ts
4305850	Stylus ϕ 2,0 mm, Carbide, $l = 14,5$ mm	800 ts
4305871	Stylus ϕ 3,0 mm, Carbide, $l = 14,5$ mm	800 ts
4309051	Stylus ϕ 2,0 mm, Ruby, $l = 14,5$ mm	800 tsr
4360001	Standard contact point, Steel, $r = 1,5$ mm	901
4360002	Standard contact point, Carbide, $r = 1,5$ mm	901 H
4360003	Standard contact point, Ruby, $r = 1,5$ mm	901 R
4360241	Pin contact point, Carbide, $l = 11$ mm, Measuring surface ϕ 1,5 mm	911 H2

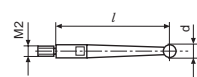

800 t

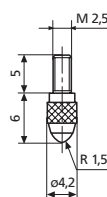

901

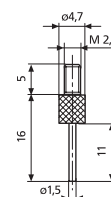

911 H2

Carrier for checking perpendicularity Digimar 817 h3



- Carrier for perpendicularity measurement
- Suitable for analog and digital dial indicators
- Ideal with P1514H measuring probe (817 CLM only)

Technical Data

Order no.	Product type
4429206	817 h3

Order no.	Mounting hole
4429206	8 mm

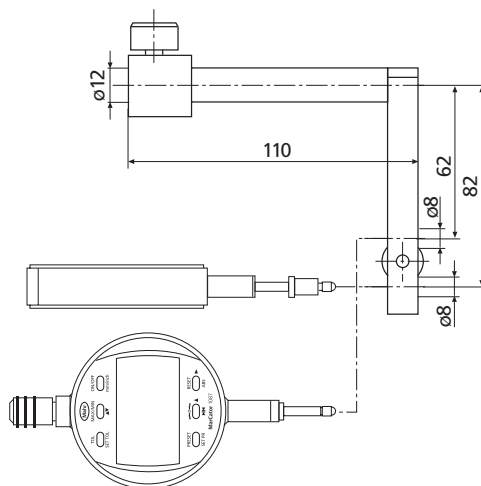

Accessories

Order no.	Product description	Product type
4102410	Data Connection Cable RS232C (2 m)	16 EXr
4337620	Digital Indicator, 0,0005 mm, 12,5 mm	1086 R
4426810	Incremental probe	P1514 H



1086 R

Height Measuring and Scribing Instrument Digimar 814 N

Functions:

- ON/OFF
 - RESET (set display to zero)
 - mm/inch
 - PRESET (for entering a numerical value)
 - MAX/MIN memory for searching the reversal point
 - TIR (MAX-MIN) for testing flatness and concentricity
 - TOL (enter tolerance limit values)
 - Switch resolution
 - DATA (Data transmission)
- Large, easy to read digital display
 - Measuring and display unit are incorporated in the measuring head
 - Data transmission via Opto RS232 C interface
 - Digital Preset
 - Zero setting in any position
 - MAX, MIN and MAX-MIN functions
 - Enter tolerance limit for 1 characteristic
 - Switch between mm/inch
 - High accuracy
 - Incremental inductive measuring system
 - Measuring head with an ball bush guide
 - Resistance free measuring system
 - Easy to operate due to the hand crank on the side of the measuring head
 - Constant measuring force; acting upwards or downwards as required
 - Measuring head can be locked in position, ideal for scribing tasks
 - With fine adjustment
 - Mains independent due to being battery operated
 - Universal application due to broad range of accessories
 - **Scope of delivery:** Height Measuring Instrument incl. Operating and display unit, Caliper arm 814t, Spherical probe 814 m, 8 mm, Battery, Instruction manual, Protection cover, Calibration certificate

Application:

- For measuring heights and center distances between bores and surfaces, widths of ledges
- For marking and scribing of workpieces



Technical Data

Order no.		4426540	4426542
Product type		814 N	
Measuring range	mm	0 – 320	0 – 620
Measuring range	inch	0 – 12.6"	0 – 24.4"
Resolution	mm	0.001, 0.01	
Resolution	inch	.00005", .0005"	
Error limit	µm	20	30
Perpendicularity error in µm	µm	20	30
Operating time max.	h	2000	
Measuring force	N	3	
Working temperature	°C / °F	20 / 68	
Operating temperature	°C / °F	5 – 40 / 41–104	
Product weight	kg / lbs	6.20 / 13.22	10.50 / 23.15
Data interface		Opto RS232C, Wireless	
Standard		Factory standard	

Height Measuring and Scribing Instrument Digimar 814 N

Accessories

Order no.	Product description	Product type
4426510	Probe arm 150 mm, Mounting hole 8 mm	814 t
4426525	Spherical probe, Ball diameter 2,0 mm	814 m
4426526	Spherical probe, Ball diameter 3,0 mm	814 m
4426512	Spherical probe, Ball diameter 4,0 mm	814 m
4426527	Spherical probe, Ball diameter 5,0 mm	814 m
4426511	Spherical probe, Ball diameter 6 mm	814 m
4426528	Spherical probe, Ball diameter 7 mm	814 m
4426509	Spherical probe, Ball diameter 8,0 mm	814 m
4426498	Spherical probe ruby ball, $\varnothing = 4,0$ mm	817 Cl-r
4426513	Disc probe	814 s
4426514	Probe holder	814 h
4426515	Scriber	814 a
4426516	Holder	814 kh
4426071	Measuring taper 0–15 mm	817 ks1
4426072	Measuring taper 14–20 mm	817 ks2
4426073	Measuring taper 18–24 mm	817 ks3
4426074	Measuring taper 23–30 mm	817 ks4
4426517	Two direction probe, $\varnothing = 4,0$ mm	814 u
4426518	Interchangeable probe arm, $\varnothing = 2,0$ mm	814 ua
4426434	Holder with connection thread M2,5 / M1,6 / M1,4	817 Cl-am
4426433	Stylus with exchangeable measuring pin	817 Cl-sa
4426435	Stylus with parallel measuring faces	817 Cl-p
4426616	Dust Cover for 0–320 mm	
4426619	Dust cover for 0–620 mm	
4102510	Data Connection Cable RS232C (2 m)	16 ESv
4102235	Transmitter for e-Stick	1082 e
4102230	Receiver	e-Stick
4102330	Adapter Cable RS232-USB (1 m)	Opto usb
4102520	Battery 3 V, CR 2032	

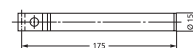

814 t

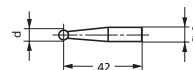

814 m

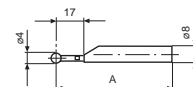

817 Cl-r

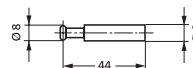

814 s

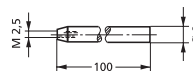

814 h

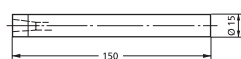

814 kh

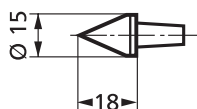

817 ks1

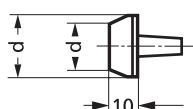

817 ks2-4

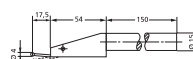

814 u

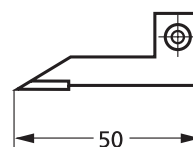

814 a

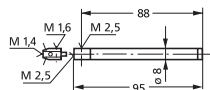

817 Cl-am

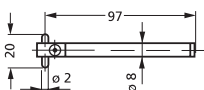

817 Cl-sa

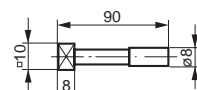

817 Cl-p



e-Stick

Height Measuring and Scribing Instrument Digimar 814 G

Functions:

- ON/OFF
- RESET (set display to zero)
- mm/inch
- PRESET (for entering a numerical value)
- MAX/MIN memory for searching the reversal point
- TIR (MAX-MIN) for testing flatness and concentricity
- TOL (enter tolerance limit values)
- Switch resolution
- DATA (data transmission)
- Large, easy to read digital display
- Measuring and display unit are incorporated in the measuring head
- Data transmission via Opto RS232 C interface
- Digital preset
- Zero setting in any position
- MAX, MIN and MAX-MIN functions
- Enter tolerance limit for 1 characteristic
- Switch between mm/inch
- High accuracy
- Incremental inductive measuring system
- Measuring head with a ball bush guide
- Resistance free measuring system
- Easy to operate due to the hand crank on the side of the measuring head
- Constant measuring force; acting upwards or downwards as required
- Measuring head can be locked in position, ideal for scribing tasks
- With fine adjustment
- Power source independent due to being battery operated
- Universal application due to broad range of accessories
- **Scope of delivery:** Height Measuring Instrument incl. Operating and display unit, Caliper arm 814t, Spherical probe 814 m, 8 mm, Battery, Instruction manual, Protection cover, Calibration certificate

Application:

- For measuring heights and center distances between bores and surfaces, widths of ledges
- For marking and scribing of workpieces



Technical Data

Order no.		4426541	4426543
Product type		814 G	
Measuring range	mm	0 - 320	0 - 620
Measuring range	inch	0 - 12.6"	0 - 24.4"
Resolution	mm	0.001, 0.01	
Resolution	inch	.00005", .0005"	
Error limit	µm	20	30
Perpendicularity error in µm	µm	20	30
Operating time max.	h	2000	
Measuring force	N	3	
Working temperature	°C / °F	20 / 68	
Operating temperature	°C / °F	5 - 40 / 41 - 104	
Product weight	kg / lbs	14.00 / 30.86	18.30 / 35.27
Plate size	mm	200 x 300	
Data interface:		Opto RS232C, Wireless	
Standard		Factory standard	

Height Measuring and Scribing Instrument Digimar 814 G

Accessories

Order no.	Product description	Product type
4426510	Probe arm 150 mm, Mounting hole 8 mm	814 t
4426525	Spherical probe, Ball diameter 2,0 mm	814 m
4426526	Spherical probe, Ball diameter 3,0 mm	814 m
4426512	Spherical probe, Ball diameter 4,0 mm	814 m
4426527	Spherical probe, Ball diameter 5,0 mm	814 m
4426511	Spherical probe, Ball diameter 6 mm	814 m
4426528	Spherical probe, Ball diameter 7 mm	814 m
4426509	Spherical probe, Ball diameter 8,0 mm	814 m
4426498	Spherical probe ruby ball, $\varnothing = 4,0$ mm	817 Cl-r
4426513	Disc probe	814 s
4426514	Probe holder	814 h
4426515	Scriber	814 a
4426516	Holder	814 kh
4426071	Measuring taper 0–15 mm	817 ks1
4426072	Measuring taper 14–20 mm	817 ks2
4426073	Measuring taper 18–24 mm	817 ks3
4426074	Measuring taper 23–30 mm	817 ks4
4426517	Two direction probe, $\varnothing = 4,0$ mm	814 u
4426518	Interchangeable probe arm, $\varnothing = 2,0$ mm	814 ua
4426434	Holder with connection thread M2,5 / M1,6 / M1,4	817 Cl-am
4426433	Stylus with exchangeable measuring pin	817 Cl-sa
4426435	Stylus with parallel measuring faces	817 Cl-p
4426616	Dust Cover for 0–320 mm	
4426619	Dust cover for 0–620 mm	
4102510	Data Connection Cable RS232C (2 m)	16 ESv
4102235	Transmitter for e-Stick	1082 e
4102230	Receiver	e-Stick
4102330	Adapter Cable RS232-USB (1 m)	Opto usb
4102520	Battery 3 V, CR 2032	

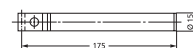

814 t

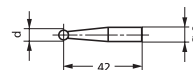

814 m

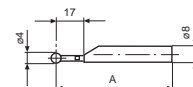

817 Cl-r

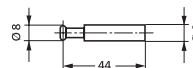

814 s

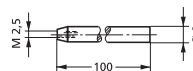

814 h

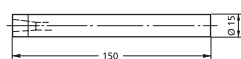

814 kh

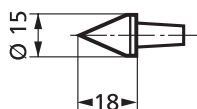

817 ks1

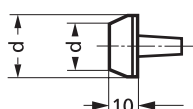

817 ks2-4

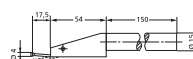

814 u

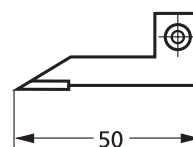

814 a

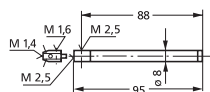

817 Cl-am



817 Cl-sa

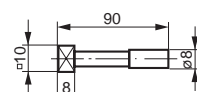

817 Cl-p



e-Stick

Height Measuring and Scribing Instrument Digimar 814 SR

REFERENCE



Functions:

- RESET (set display to zero)
 - mm/inch
 - ABS (Switch between Relative and Absolute measurement)
 - Lock/Unlock
 - PRESET (for entering a numerical value)
 - DATA (Data transmission via connection cable)
 - AUTO-ON / OFF
- Battery life up to 3 years
 - Max. measuring speed 1,5 m/s (60"/s)
 - MarConnect Data output: choose either
 - USB
 - OPTO RS232C
 - Digimatic
 - High contrast Liquid Crystal Display with 12 mm sized digits
 - Sturdy heavy-duty base, easy to handle
 - Hardened and lapped contact surface which produce both a smooth and even movement
 - Slide and beam made of hardened stainless steel
 - Hand crank for positioning and measuring
 - Fine adjustment
 - Locking screw
 - Interchangeable scriber point, carbide tipped
 - **Software:** MarCom Professional free download:
www.mahr.com/marcom
(only for Mahr data cables and wireless systems with USB and RS232 interface)
 - **Scope of delivery:** Scriber, Battery, Carton, Instruction manual

Application:

- Scribing and marking of work pieces
- Measuring Heights and distances



Technical Data

Order no.		4426100	4426101
Product type		814 SR	
Measuring range	mm	0 - 350	0 - 600
Measuring range	inch	0 - 14"	0 - 24"
Resolution	mm	0,01	
Resolution	inch	.0005"	
Error limit	µm	40	50
Operation time max.	h	4000	
Operating temperature	°C / °F	10 - 40 / 50 - 104	
Product weight	kg / lbs	7.00 / 15.43	8.00 / 17.64
Data interface:		Opto RS232C, Digimatic, USB, Wireless	
Standard		Factory standard	

Order no.	a	b	c	d
	mm	mm	mm	mm
4426100	62	180	35	580
4426101	62	180	35	835

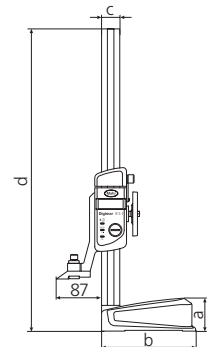

Accessories

Order no.	Product description	Product type
4123867	Measuring/Scriber Point, carbide tipped	814 SRs
4123041	Holder for test indicators	27 Sp
4102357	Data Connection Cable USB (2 m)	16 EXu
4102915	Digimatic data cable (2 m)	16 EWd
4102410	Data Connection Cable RS232C (2 m)	16 EXr
4102230	Receiver	e-Stick
4102231	Transmitter for e-Stick	16 EWe
4102520	Battery 3 V, CR 2032	

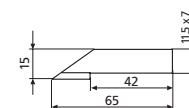

814 SRs;

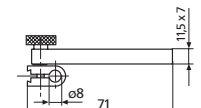

27 Sp



e-Stick



16 EWe